



# CONTENTS

<b>BEFORE YOU BEGIN.....</b>	<b>2</b>	Flash.....	25
Glossary.....	3	Temporary Tone Dialing.....	25
Features List.....	4	Conference Calls.....	25
Audible Signals.....	5	Transfer a Call.....	26
<b>INSTALLATION.....</b>	<b>6</b>	Low Battery Indicator.....	26
Table/Desk Installation.....	6	<b>SPEED DIAL OPERATION.....</b>	<b>27</b>
Wall Installation.....	8	Storing a Number in	
Convenience Ports.....	12	a Speed Dial Location.....	28
<b>FEATURE SET UP.....</b>	<b>13</b>	Reviewing a Speed Dial Entry.....	28
Set the Time/Date.....	14	Making a Speed Dial Call.....	28
Assign an Extension Number		<b>INTERCOM OPERATION.....</b>	<b>29</b>
to Your Phone.....	14	Basic Intercom Operations.....	30
Turn the Ringer On or Off		Making an Intercom Call with	
for Each Line.....	14	the Handset.....	30
Select the Ringer Type.....	15	Making an Intercom Call with the	
Set Delay Ring.....	15	Speakerphone or Headset.....	31
Turn Line Usage On or Off		Answering an Intercom Call.....	31
for Each Line.....	15	Making a Single-phone Page.....	31
Assign the Prime Line		Answering a Single-phone Page.....	31
(Line Preference).....	16	Switching Between an Intercom	
Assign the Line Group		Call and a Single-phone Page.....	31
for this Phone.....	16	Ending an Intercom or Page Call.....	31
Turn Auto-Mute On or Off.....	16	Paging All Phones.....	32
Set Audio Mode.....	17	Answering a System-wide Page.....	32
Set the Dial Mode.....	17	Making an Intercom	
Set the Flash Time.....	17	Conference Call.....	32
Turn Hold Reminder On or Off.....	17	Room Monitor.....	32
Set Your Phone to be the Centrex		<b>ADDING A FAX MACHINE.....</b>	<b>33</b>
Console Phone.....	18	Using a Fax Switch.....	33
Program the Centrex Console		<b>IN CASE OF DIFFICULTY.....</b>	<b>34</b>
Delayed Ring Time.....	18	<b>EXPANDING THE PHONE SYSTEM ..</b>	<b>36</b>
Erase All Settings and Return		Line Groups.....	36
the Phone to Default Settings.....	18	Private Lines.....	37
<b>TELEPHONE OPERATION.....</b>	<b>19</b>	<b>CENTREX OPERATION.....</b>	<b>38</b>
Making or Answering a Call.....	20	Setup Checklist.....	38
Timer.....	21	Enabling the Console Phone.....	38
Pause.....	21	Console Operation.....	38
Call Privacy.....	22	Setting Ring Delay Duration.....	39
Do Not Disturb.....	22	Answering a Delayed Ring.....	39
Line-in-Use Lights.....	23	Picking Up Another Station's Line.....	39
Volume.....	23	<b>INDEX.....</b>	<b>40</b>
Redial.....	23		
Auto Redial.....	24		
Hold.....	24		
Switch Between Lines.....	24		
Mute.....	25		

# BEFORE YOU BEGIN

This 944 telephone is fully compatible with any AT&T Four-Line Intercom Speakerphone 964 or 955 units you may have installed. You can use up to a total of 12 944/955/964 units together as extensions on your phone system.

- Check to be sure your box contains:
  - 1 Telephone
  - 1 Handset
  - 1 Handset cord
  - 1 Mounting base
  - 2 Seven-foot line cords
  - 1 Eight-inch line cord
  - 1 Power adapter
  - 1 Warranty insert
  - 1 9V battery
  - 1 User's Manual
- You must have a modular telephone jack and an electrical outlet not controlled by a wall switch near where you're installing the phone.
- The total length of telephone wiring used in this system is important. If the total length of telephone wiring is more than 600 feet, you may need to use a special filter device. You can call 1 800 222-3111 for information about this filter. You'll need to contact a professional to install this filter.
- Identify the number of phone lines you'll use.
- Plan the layout of your phone system.
- All connected phones must have the same Line 1 phone number for the Intercom and Page features to work.
- Assign a different Intercom Extension Number (11 through 22) to each system phone. You'll need to do this individually at each telephone.
- Decide if you want a private line. A private line does not appear on all connected phones.
- Choose your setting for each feature. You will need to program the features during installation (see "Features List").

# BEFORE YOU BEGIN

## Glossary

**Centrex Service:** A special subscriber service which may be available from your local telephone company for a fee. The 944 telephone can be used with Centrex Service.

**DND:** When activated the Do Not Disturb feature prevents interruptions during a call.

**Line Group:** A group of system phones sharing some lines within a multi-phone system.

**Navigation buttons:** These are the buttons used when programming your 944 phone and for scrolling through feature options (▲, ▼, ►, ◀, **END**, **SAVE**).

**Phone System:** Two or more 944/955/964 phones combined into an interacting system of shared lines. You can have up to 12 phones and up to 15 telephone lines in the system.

**Prime Line:** This is the line on your phone you designate to be selected automatically when you lift the handset, press **SPEAKER**, or press **HEADSET**.

**System Phone:** Any 944, 955 or 964 phone in your phone system.

# BEFORE YOU BEGIN

## Features List

*NOTE: An \* indicates the default setting for each feature.*

*NOTE: One ring is equal to about six seconds, two rings equals twelve seconds, and so on.*

<b>Feature</b>	<b>Function</b>	<b>Setting Option(s)</b>
TIME/DATE	Set time and date	01:00AM 01/01 Sunday*
EXTENSION NO	Assign extension number for this phone	11-22*
RINGER ON/OFF	Turn ringer on or off for each line	On* or Off
RINGER TYPE	Select ring pattern for this phone	Type 1*, 2, 3, 4
DELAY RING	Select desired time to delay Central Office ring	Off*, 2, 4, 6, ... 30 seconds
LINE USAGE	Turn line usage on or off for each line	On* or Off
PRIME LINE	Assign a line on this phone to be selected automatically when you lift the handset, press <b>[SPEAKER]</b> , or press <b>[HEADSET]</b>	Line 1*, 2, 3, 4
LINE GROUP	Assign your phone to a Line Group	Line Group 4*-15 or PRV (private)
AUTO-MUTE	Turn Auto-Mute on or off (sounds at this extension will be heard automatically when paged)	On* or Off
AUDIO MODE	Choose default mode for calls connected with handset in cradle	Speakerphone* or Headset
TONE/PULSE	Set dial mode for touch-tone or dial pulse (rotary) dialing	Tone* or Pulse
FLASH TIME	Set length of signal sent when you press <b>[FLASH]</b>	0.3 seconds - 0.9 seconds 0.7 seconds*
HOLD REMINDER	Turn audible reminder that a call at this extension is on hold on or off	On* or Off
CONSOLE	Specify whether your phone is the Centrex Console phone for your phone system	On or Off*
CSL DELAY RING	Set time to delay ring for Centrex Console phone	Off*, 2, 4, 6, ... 30 seconds
RESET ALL!!!	Return all settings to default settings	(Defaults)

# BEFORE YOU BEGIN

## Audible Signals

<i>When you hear:</i>	<i>It means:</i>
A rapid double-ring pattern, repeating	You have an incoming intercom call.
Long single ring, repeating	You have an incoming transferred call.
Short single ring, repeating	The extension number you just programmed has already been assigned. Choose another number for this extension.
Short single tone, repeating	The extension you are calling is in DND mode.
Long single tone, repeating	The extension you are calling is busy.

# INSTALLATION

**NOTE:** If you are installing multiple phones in your telephone system, you must install and program one set at a time. If more than one extension is assigned the same extension number, a repeating short ring (error ring) will sound at all extensions. Reassign extension numbers, being sure that each extension has a different number from 11 to 22 (see "Assign an Extension Number to Your Phone" in FEATURE SET UP).

## Table/Desk Installation

### 1 Install one 9V battery.

- Press in on the tabs and remove the telephone base.
- Use a small Phillips head screwdriver to remove the screw and open the battery door.
- Insert the 9V battery (included), and replace the screw to close the battery door.
- Replace the telephone base.

**NOTE:** The battery retains telephone memory in the event of a power failure. If power fails and a working battery is installed, all four lines of this phone will work only to answer calls with the handset or headset, and dial calls using the key pad and the Speed Dial or Redial features. No other features will work until power is restored.

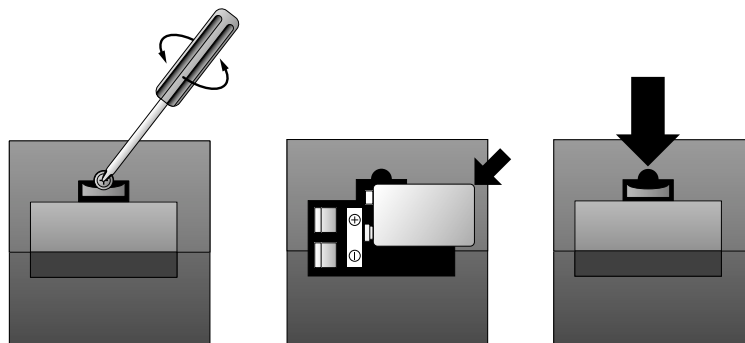

# INSTALLATION

## 2 Connect the telephone line cords to the telephone.

- **Four One-Line Jacks** (To use this installation option, you'll need to purchase two two-line adapters. Adapters are available at retail stores or by calling 1 800 222-3111.)

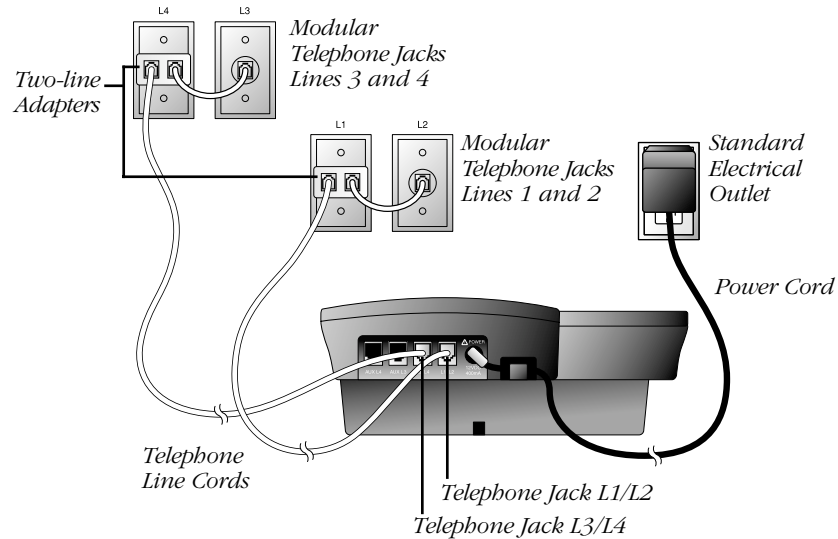

- **Two Two-Line Jacks**

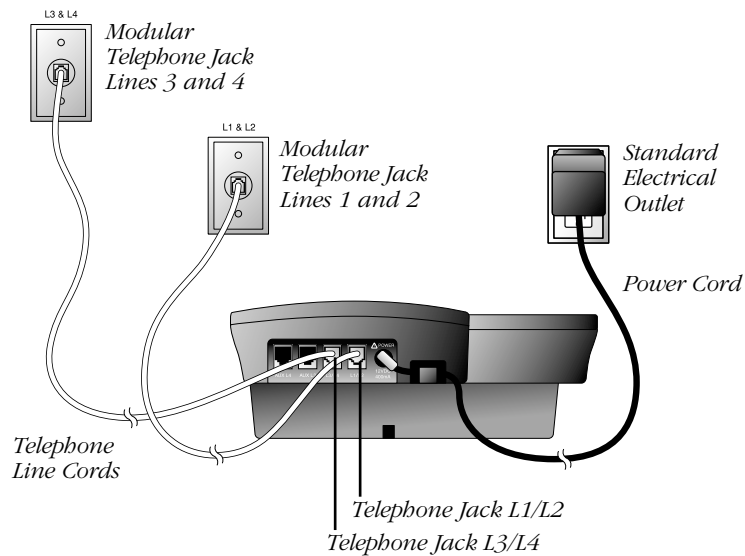

# INSTALLATION

## 3 Connect the handset cord.

Plug one end of the coiled handset cord into the jack on the left side of the phone. Plug the other end into the handset, and hang up.

## 4 Connect the power adapter.



Use only the power adapter provided with this product. To obtain a replacement, call 1 800 222-3111.

Plug one end of the power adapter into the jack labeled **POWER** on the back of the phone. Plug the other end into a standard electrical outlet not controlled by a wall switch.

*NOTE: The screen will display POWERFAIL the first time you plug in the phone. Press any key to clear the screen.*

## 5 Check for dial tone.

Lift the handset and listen for a dial tone. If you cannot hear a dial tone, turn to IN CASE OF DIFFICULTY.

## 6 Initialization.

As soon as you connect the power cord, the phone runs a quick self-test and the screen displays Initializing.. for about seven seconds. When the test is complete, the phone enters an initial setup mode and the screen displays press PROG to setup your phone. See FEATURE SET UP beginning on page 13.

*NOTE: The phone will run through this same initialization anytime it is reconnected to AC power (i.e., after a power failure or when the unit has been unplugged).*

## Wall Installation

### 1 Reverse the handset tab.

Hold down the switchhook, then pull the tab out and rotate it 180 degrees. Push the tab down into the grooves so it settles into position.

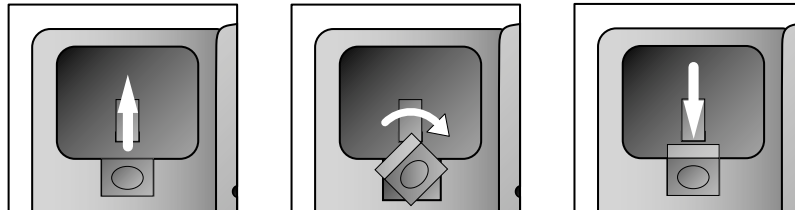

# INSTALLATION

## 2 Install one 9V battery.

- Press in on the tabs and remove the telephone base.
- Use a small Phillips head screwdriver to remove the screw and open the battery door.
- Insert the 9V battery (included), and replace the screw to close the battery door.
- Replace the telephone base.

*NOTE: The battery retains telephone memory in the event of a power failure. If power fails and a working battery is installed, all four lines of this phone will work only to answer calls with the handset or headset, and dial calls using the keypad and the Speed Dial or Redial features. No other features will work until power is restored.*

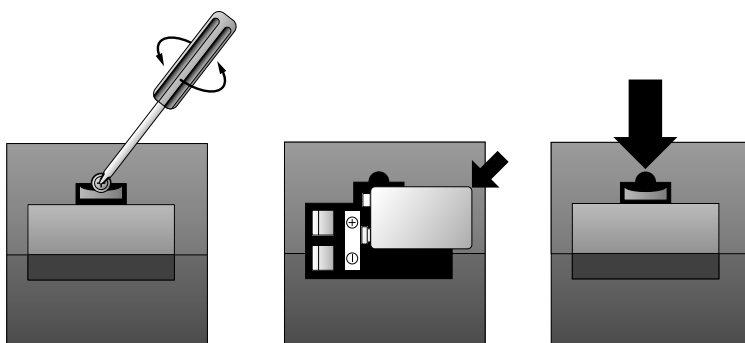

## 3 Connect the telephone line cords to the telephone.

Please refer to line cord connection instructions in **Step 2** of “Table/Desk Installation” on page 7.

## 4 Turn the base, as shown, and attach it to the bottom of the phone.

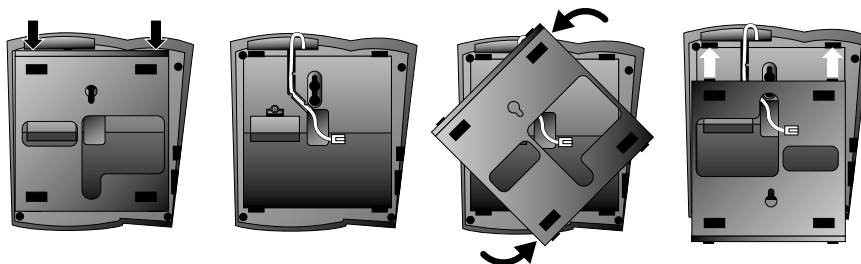

# INSTALLATION

**5 Connect the handset cord.**

Plug one end of the coiled handset cord into the jack on the left side of the phone. Plug the other end into the handset, and hang up.

**6 Connect the power adapter to the telephone.**



Use only the power adapter provided with this product. To obtain a replacement, call 1 800 222-3111.

Plug one end of the power adapter into the jack labeled **POWER** on the back of the phone.

***NOTE:** The screen will display POWERFAIL the first time you plug in the phone. Press any key to clear the screen.*

**7 Check for dial tone.**

Lift the handset and listen for a dial tone. If you cannot hear a dial tone, turn to IN CASE OF DIFFICULTY.

**8 Mount the phone on the wall.**

- **Four One-Line Jacks**

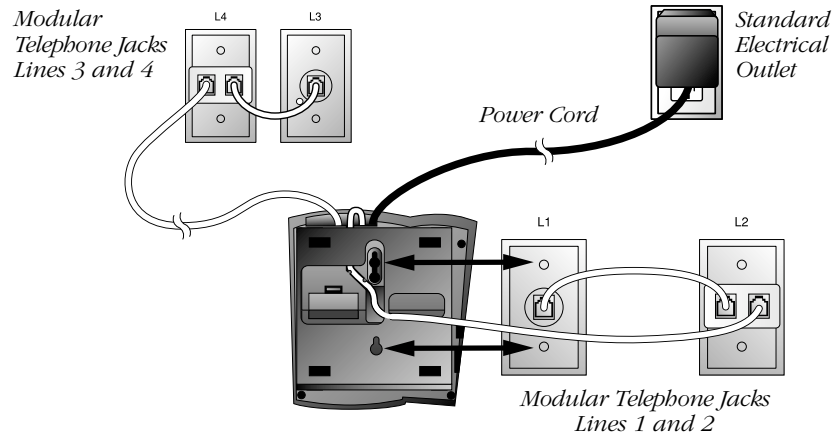

# INSTALLATION

- **Two Two-Line Jacks**

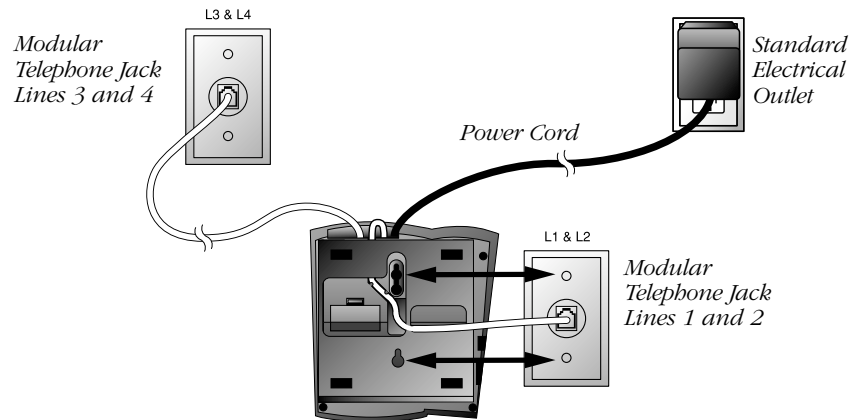

**9 Plug the power adapter into a standard electrical outlet not controlled by a wall switch.**

**10 Initialization.**

As soon as you connect the power cord, the phone runs a quick self-test and the screen displays *Initializing..* for about seven seconds. When the test is complete, the phone enters an initial setup mode and the screen displays *press PROG to setup your phone*. See **FEATURE SET UP** beginning on page 13.

**NOTE:** *The phone will run through this same initialization anytime it is reconnected to AC power (i.e., after a power failure or when the unit has been unplugged).*

# INSTALLATION

## Convenience Ports

If you want to connect another device (such as a modem or fax machine) to the wall jack, you can use the jacks on the phone labeled AUX. These convenience ports use Lines 3 and 4; a call picked up on Line 3 or 4 at another extension may interrupt fax, modem, or message transmission.

- **Four One-Line Jacks**

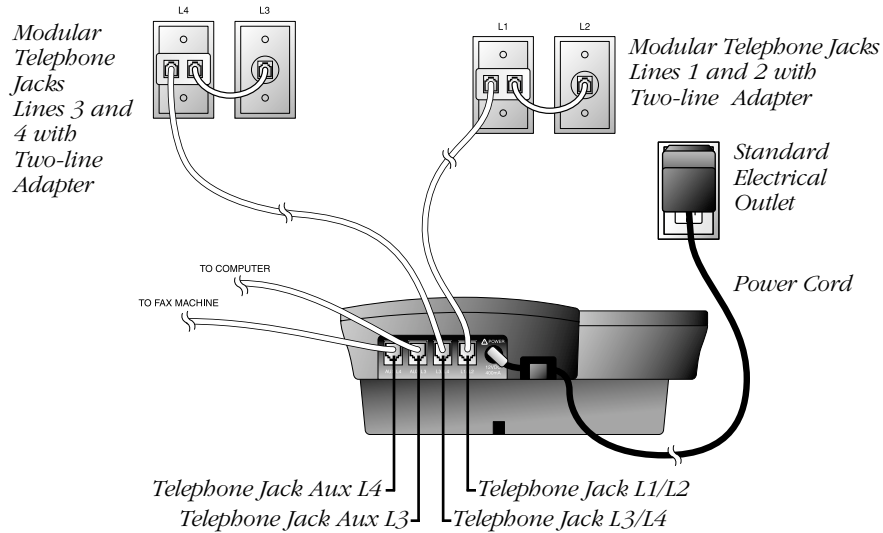

- **Two Two-Line Jacks**

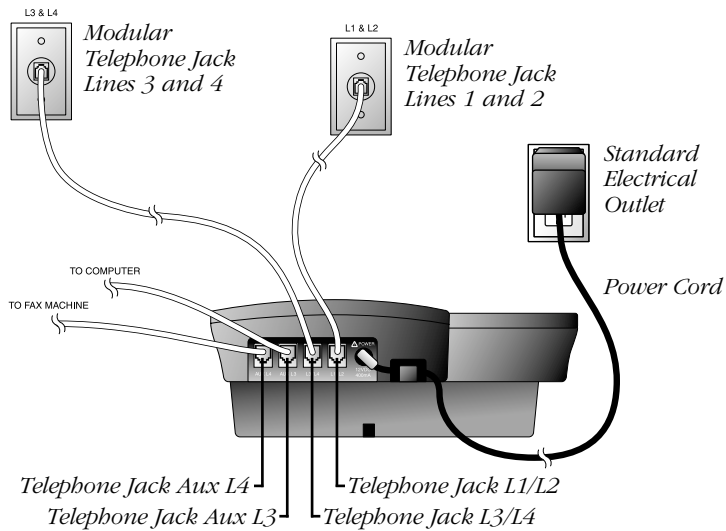

# FEATURE SET UP

Use the Navigation buttons to program or change the features setup.

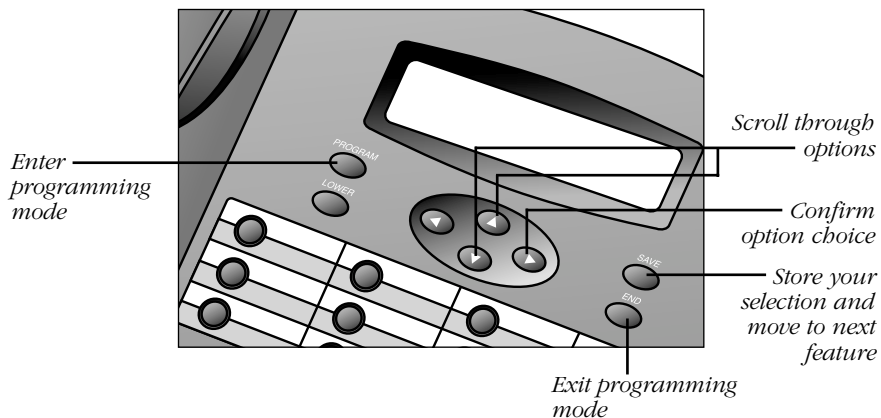

- Press **PROGRAM** to enter the programming mode. The screen displays:

```
PROGRAM:Press ▲▼  
or Enter Number
```

**NOTE:** If you do not press a key to continue programming within 20 seconds, the telephone automatically exits the programming mode.

- Press ▼ or ▲ repeatedly to move through the list of options.
- Press ► to choose the option currently displayed.
- Press **SAVE** to store your selections and return to the 'home screen' for the feature currently displayed.

```
TIME/DATE _____ Feature  
▲▼:select:enter _____ Options
```

You can set up one feature at a time or you can set up a feature and then move on to set up another feature. After you change one feature, press ▲ or ▼ to select another feature. When you are finished with features setup, press **END** to exit programming mode.

**NOTE:** After a feature is successfully programmed, the phone beeps once. If the phone beeps twice, repeat the steps to set up the feature.

# FEATURE SET UP

## Set the Time/Date

- 1 Press **PROGRAM**.
- 2 Press **▼** until the screen displays TIME/DATE.
- 3 Press **▶**, The screen displays the current setting.
- 4 Press **▼** or **▲** to change the hour setting.
- 5 Press **SAVE** to store the hour setting.
- 6 Press **▼** or **▲** to change the minutes setting.
- 7 Press **SAVE** to store the minutes setting.
- 8 Press **▼** or **▲** to select AM or PM.
- 9 Press **SAVE** to store the setting.
- 10 Press **▼** or **▲** to change the month.
- 11 Press **SAVE** to store the setting.
- 12 Press **▼** or **▲** to change the day of the month.
- 13 Press **SAVE** to store the setting. The screen displays the current day of the week setting.
- 14 Press **▼** or **▲** to change the day of the week.
- 15 Press **SAVE** to store the setting.

## Assign an Extension Number to Your Phone

- 1 Press **PROGRAM**.
- 2 Press **▼** until the screen displays EXTENSION NO, then press **▶**.
- 3 Press **▼** or **▲** to select the desired extension number (from 11 to 22).
- 4 Press **SAVE** to store your selection.

**NOTE:** If you duplicate an extension number, you will hear a repeating short ring. Repeat **Steps 1-4** and assign a different number (from 11 to 22).

## Turn the Ringer On or Off for Each Line

- 1 Press **PROGRAM**.
- 2 Press **▼** until the screen displays RINGER ON/OFF, then press **▶**.
- 3 Press **▼** or **▲** until the screen displays the desired line number, then press **▶**. The screen displays the current setting for that line.
- 4 Press **▼** or **▲** to change the setting.
- 5 Press **SAVE** to store your selection.
- 6 Repeat **Steps 1-5** to change the ringer setting for additional lines.

# FEATURE SET UP

## Select the Ringer Type

- 1 Press **PROGRAM**.
- 2 Press **▼** until the screen displays RINGER TYPE, then press **▶**.
- 3 Press **▼** or **▲** to select the desired setting. You will hear a sample of each ringer type as you move through the settings.
- 4 Press **SAVE** to store your selection.

## Set Delay Ring

Set the length of time before incoming calls will ring at this extension.

- 1 Press **PROGRAM**.
- 2 Press **▼** until the screen displays DELAY RING, then press **▶**.
- 3 Press **▼** or **▲** to select the desired setting. (One ring is about six seconds.)
- 4 Press **SAVE** to store your selection.

## Turn Line Usage On or Off for Each Line

If you are not using all four phone lines, you need to turn off Line Usage for the unused lines. If you expand to a third or fourth line, turn Line Usage back on.

You may also restrict the use of certain lines on this phone to intercom and paging only, by turning off Line Usage for each line to be restricted. When Line Usage is turned off, that line cannot be used to answer incoming calls or to make outgoing or transfer calls.

- 1 Press **PROGRAM**.
- 2 Press **▼** until the screen displays LINE USAGE, then press **▶**.
- 3 Press **▼** or **▲** until the screen displays the desired line number, then press **▶**.
- 4 Press **▼** or **▲** to change the setting.
- 5 Press **SAVE** to store your selection.
- 6 Repeat **Steps 1-5** to change the Line Usage status for additional lines.

# FEATURE SET UP

## Assign the Prime Line (Line Preference)

- 1 Press **PROGRAM**.
- 2 Press **▼** until the screen displays PRIME LINE, then press **▶**.
- 3 Press **▼** or **▲** to select the desired setting.
- 4 Press **SAVE** to store your selection.

## Assign the Line Group for this Phone

- 1 Press **PROGRAM**.
- 2 Press **▼** until the screen displays LINE GROUP, then press **▶**.
- 3 Press **▼** or **▲** to select the desired setting.
- 4 Press **SAVE** to store your selection.

## Turn Auto-Mute On or Off

Choose whether sounds at this extension will be heard automatically in response to a page (Auto-Mute Off) or only when **MUTE** is pressed.

Auto-Mute Off permits hands-free conversation and room monitoring;

Auto-Mute On protects privacy.

- 1 Press **PROGRAM**.
- 2 Press **▼** until the screen displays AUTO MUTE, then press **▶**.
- 3 Press **▼** or **▲** to change the setting.
- 4 Press **SAVE** to store your selection.

# FEATURE SET UP

## Set Audio Mode

Choose the mode (speakerphone or headset) the phone will automatically use to make and answer calls when the handset is in the cradle.

- 1 Press **PROGRAM**.
- 2 Press **▼** until the screen displays AUDIO MODE, then press **▶**.
- 3 Press **▼** or **▲** to change the setting.
- 4 Press **SAVE** to store your selection.

**NOTE:** *If you have programmed headset as the default mode but the headset is not plugged in, the phone will switch to speakerphone.*

## Set the Dial Mode

- 1 Press **PROGRAM**.
- 2 Press **▼** until the screen displays TONE/PULSE, then press **▶**.
- 3 Press **▼** or **▲** to change the setting.
- 4 Press **SAVE** to store your selection.

## Set the Flash Time

**NOTE:** *If you are using this phone within the United States, there is no need to change the Flash Time from the default setting (0.7 seconds).*

- 1 Press **PROGRAM**.
- 2 Press **▼** until the screen displays FLASH TIME, then press **▶**.
- 3 Press **▼** or **▲** to select the desired setting.
- 4 Press **SAVE** to store your selection.

## Turn Hold Reminder On or Off

- 1 Press **PROGRAM**.
- 2 Press **▼** until the screen displays HOLD REMINDER, then press **▶**.
- 3 Press **▼** or **▲** to change the setting.
- 4 Press **SAVE** to store your selection.

# FEATURE SET UP

You will need to program the next two features if this phone is the designated Console Phone for your Centrex system:

## Set Your Phone to be the Centrex Console Phone

*NOTE: This feature is for use with Centrex systems only.*

- 1 Press **PROGRAM**.
- 2 Press **▼** until the screen displays **CONSOLE**, then press **▶**.
- 3 Press **▼** or **▲** to change the setting.
- 4 Press **SAVE** to confirm your selection.

## Program the Centrex Console Delayed Ring Time

*NOTE: This feature is for use with Centrex systems only.*

Set the length of time the phone will route your calls to the Centrex Console phone. One ring is about six seconds.

- 1 Press **PROGRAM**.
- 2 Press **▼** until the screen displays **CSL DELAY RING**, then press **▶**.
- 3 Press **▼** or **▲** to select the desired setting.
- 4 Press **SAVE** to confirm your selection.

## Erase All Settings and Return the Phone to Default Settings

- 1 Press **PROGRAM**.
- 2 Press **▼** until the screen displays **RESET ALL**.
- 3 Press **▶**. The screen displays:



RESET ALL?  
Press "7"

- 4 Press **7** within three seconds to confirm the **RESET ALL** command. The screen displays:



Reset!

# TELEPHONE OPERATION

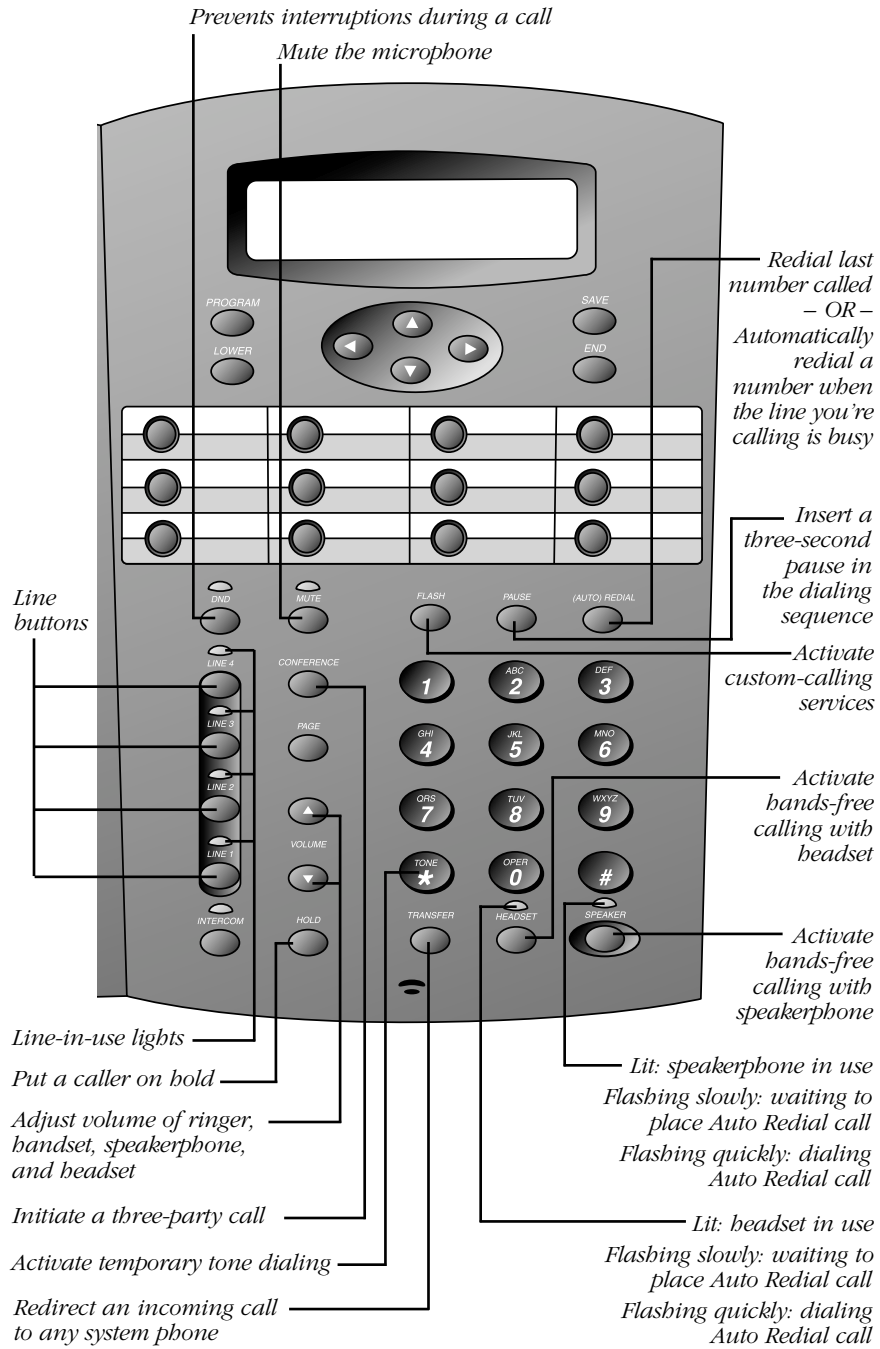

# TELEPHONE OPERATION

*NOTE: When you make a call, the phone selects the Prime Line you programmed. When you answer a call, the phone automatically selects the ringing line.*

## Making or Answering a Call

*NOTE: This phone will automatically make and answer calls in the mode (speakerphone or headset) you programmed (see “Set Automatic Audio Mode” in FEATURE SETUP). Follow the directions below to choose a mode manually. If the phone is in use on one line, any other calls made or answered will use the same mode already in use.*

*NOTE: If you dial a phone number longer than 15 digits, the screen will display only the last 13 digits.*

### Handset

**To make a call**, lift the handset and dial the call.

**To answer a call**, lift the handset. Replace the handset to end the call.

**To override automatic line selection**, lift the handset, then press and release a LINE button

— OR —

Press the LINE button for the line you wish to select, then lift the handset.

### Speakerphone

**To make a call**, press and release the desired LINE button or **[SPEAKER]**.

The SPEAKER light goes on. Wait for a dial tone, then dial the call.

**To answer a call**, press **[SPEAKER]** or press the LINE button of the incoming call. Press **[SPEAKER]** again to end the call.

*NOTE: If headset is programmed as the default mode (see “Set Automatic Audio Mode” in FEATURE SETUP), you must press **[SPEAKER]** to activate the speakerphone.*

### Headset

You can use this phone hands-free when you install a 2.5mm headset.

Headsets are available for purchase in retail stores (comcode #108041732) or by calling 1 800 222-3111.

Make sure the headset is plugged into the headset jack located to the left of the handset jack on the left side of the telephone base. You will hear a double-beep if you press **[HEADSET]** and the headset is not plugged in.

*NOTE: If headset is programmed as the default mode, (see “Set Automatic Audio Mode” in FEATURE SET UP) but the headset is not plugged in, the phone will switch to speakerphone.*

# TELEPHONE OPERATION

**To make a call**, press and release **HEADSET** or press the desired LINE button and then press **HEADSET**. The HEADSET light goes on. Wait for a dial tone, then dial the call.

**To answer a call**, press **HEADSET**. Press **HEADSET** again to end the call.

**NOTE:** *If speakerphone is programmed as the default mode (See “Set Automatic Audio Mode” in FEATURE SET UP), you must press **HEADSET** to activate the headset.*

## Switching Modes

**To switch from handset to headset or speakerphone**, press **HEADSET** or **SPEAKER**, then replace the handset (for headset, headset must be plugged in).

**To switch from speakerphone to handset**, lift the handset. (Do not press **SPEAKER** or the call will be disconnected.)

**To switch from headset to handset** (when handset is in the cradle), lift the handset.

**To switch from headset to handset** (when handset is off-hook), press **HEADSET** again.

**To switch from headset to speakerphone** (when handset is in the cradle), press **SPEAKER**.

**To switch from headset to speakerphone** (when handset is off-hook), press **SPEAKER** and replace the handset.

**To switch from speakerphone to headset**, insert the headset plug into the jack, and press **HEADSET**.

**To override automatic line selection**, press and release a LINE button (this activates the speakerphone or headset, whichever is programmed as the default mode).

## Timer

When you make or answer a call, the timer automatically starts. The screen displays the elapsed time in minutes and seconds for the first hour (up to 59:59) and then begins again. The timer stops automatically when you hang up and the recorded time is displayed for about 10 seconds.

The timer also stops when you place a call on hold and resets when you release hold.

## Pause

While dialing a call press **PAUSE** where you want to insert a three-second pause in the dialing sequence. This is useful if you are dialing a long-distance access code and the long-distance carrier requires a pause between the access code and the telephone number.

# TELEPHONE OPERATION

## Call Privacy

To ensure call privacy, the phone allows only one set at a time to use a line.

## Canceling Call Privacy

During the call, press the LINE button for the call. You'll hear a short beep. Others can now join the call.

## Restoring Call Privacy

Press the LINE button again during the call. You'll hear a double-beep. The other phones will be dropped from the call.

*NOTE: Call privacy is automatically restored when you end the call.*

*NOTE: When a non-system phone answers a call, any other system phone can pick up the call by pressing the LINE button. Once a system phone picks up the call, Call Privacy is activated and no other system phones can listen to the call unless Call Privacy is canceled, but non-system phones which share that line can still join the call.*

## Do Not Disturb

When your phone is off-hook (i.e., you are on a call) you will hear a low volume ring when you receive an intercom call. In order to prevent even this audible signal, activate the Do Not Disturb feature. When you activate this feature you will not hear paging tones, voice paging, or incoming call rings. Instead, the LINE light flashes and the INTERCOM light goes on to signal an incoming call or page. If you receive an intercom call, the INTERCOM light flashes, and the intercom number calling you appears on the display.

- 1 Press **[DND]** to prevent interruptions. The DND light goes on and the screen display includes **[DND]**.
- 2 Press **[DND]** again to resume normal call alerts. The DND light goes off and the screen no longer shows **[DND]**.

When this feature is activated, callers from within your phone system will hear a short repeating tone (like a fast busy signal).

# TELEPHONE OPERATION

## Line-in-Use Lights

Whenever a line is in use, the Line light will be on. Use the following chart to determine the exact status of a line.

<b>A Line light shows:</b>	<b>To show that:</b>
On steadily	The line is in use at another extension
Slow, even blinks	You have an incoming direct call
Rapid, even blinks	You have an incoming transfer call
Flashing pattern long on, brief off	You are talking on the line
Alternating one long and one short flash	The line is on hold at your extension
Two short and one long flash, repeating	The line is on hold at another extension

## Volume

### Handset/Speakerphone/Headset Volume Control

When you are on a call, press Volume ▲ to increase call volume. Press Volume ▼ to decrease volume. You will hear a beep when you reach the minimum or maximum level.

### Ringer Volume

You can adjust the ringer volume while the phone is ringing. While the line is ringing, press Volume ▲ or Volume ▼ to reach the desired level. This phone has four ringer volume levels. Each time you adjust the ringer, you will hear a sample indicating the volume level.

### Turning Ringer Off

You may turn the ringer for each line on or off. See “Turn the Ringer On/Off for Each Line” in FEATURE SET UP.

## Redial

The last number dialed on this phone (up to 32 digits) is stored in redial memory until you dial another number.

### Handset

To dial the same number again, lift the handset, listen for the dial tone, then press **(AUTO) REDIAL**.

# TELEPHONE OPERATION

## Speakerphone or Headset

To dial the same number again, press **(AUTO) REDIAL**. The phone automatically selects an available line and dials the last number.

*NOTE: You will experience a delay before the call is dialed when using the Redial feature. This is normal.*

## Auto Redial

Press **(AUTO) REDIAL** twice and the phone automatically selects an available line

— OR —

Press a **LINE** button to select a line, then press **(AUTO) REDIAL** twice.

The phone redials the number you just called, and continues up to 10 times until the other line rings, or until you cancel Auto Redial.

When you hear the line ringing or the other party answers, lift the handset or press **(SPEAKER)** or **(HEADSET)** to complete the call and speak with the other party. If you don't complete the call, the phone disconnects after 30 seconds.

To cancel Auto Redial, press any button (except Volume **(▲)** or **(▼)**).

## Hold

Press and release **(HOLD)**. The light of the line on hold flashes, and a double-beep sounds every 30 seconds to remind you the call is on hold. (To turn off the reminder beep, see "Turn Hold Reminder On or Off" in FEATURE SET UP). You can replace the handset in the cradle without disconnecting the call. The speakerphone is automatically turned off.

To release Hold, press and release the **LINE** button of the call on hold.

*NOTE: The phone automatically disconnects a call on hold after 20 minutes. To keep a call on hold longer than 20 minutes, release Hold before 20 minutes and then place the call on hold again.*

*NOTE: You cannot put an intercom call on hold.*

*NOTE: If a line is in use, pressing **(INTERCOM)** or **(PAGE)** will place the line on hold and activate the intercom.*

## Switch Between Lines

- 1 Press and release **(HOLD)** to keep a call on the first line.
- 2 Press and release the **LINE** button of another line to make or answer another call.

*NOTE: If you switch lines without pressing **(HOLD)** first, you will drop the call.*

# TELEPHONE OPERATION

## Mute

This feature lets you mute the telephone so that you can hear the other party, but the other party can't hear you.

**To activate this feature**, press and release **MUTE**. The MUTE light goes on.

**To return to the conversation**, press and release **MUTE** again.

*NOTE: Switching from handset to speakerphone or headset, or from speakerphone or headset to handset, changing lines, and putting a call on hold also cancel Mute.*

## Flash

Use **FLASH** instead of the switchhook to activate telephone company subscriber services such as Call Waiting or Three-Way Calling.

To adjust the length of the Flash signal, see "Set the Flash Time" in FEATURE SET UP.

## Temporary Tone Dialing

If you have dial pulse (rotary) service, you can change from dial pulse to touch tone dialing during a call by pressing **\*TONE**. This is useful if you need to send touch tone signals for access to telephone banking or long-distance services.

- 1 Dial the number.
- 2 Press and release **\*TONE**. Buttons pressed after this send touch tone signals.
- 3 After you hang up, the phone automatically returns to rotary service.

## Conference Calls

This feature lets you set up a three-party call by using two lines at the same time. You can also join an intercom call with a call on an outside line.

- 1 Make or answer a call.
- 2 Press and release **HOLD**.
- 3 Call someone on another line.
- 4 When this call is answered, press **CONFERENCE**. The three-party conference begins immediately.
- 5 To end a conference call, hang up. All parties will disconnect.

# TELEPHONE OPERATION

## To talk privately with one party:

- 1 Press **HOLD** to place both lines on hold.
- 2 Press a **LINE** button to talk privately with the person on that line.
- 3 Press **CONFERENCE** to resume the conference call.

## To drop one line:

Press the **LINE** button of the party you want to keep. The other line will be dropped.

*NOTE: Occasionally, the far-end parties on a conference call might not hear one another.*

## Transfer a Call

You can transfer a call you answer to any other system phone. Once you transfer a call, it can be picked up at any other system phone, not just at the extension you called.

While on a call:

- 1 Press **TRANSFER**.
- 2 Enter the extension number where you're transferring the call.
- 3 Hang up.

Your phone reminds you with a double-beep every 30 seconds when a transferred call has not been answered.

**To answer a transferred call**, pick up the handset or press the **LINE** button of the call to use the speakerphone or headset. You will know an incoming call is a transferred call by the distinctive long rings.

*NOTE: If you do not dial an extension within 10 seconds, the transfer is automatically cancelled.*

*NOTE: If a transferred call is not picked up within 20 minutes, the phone will automatically disconnect the call.*

## Low Battery Indicator

The screen displays **LOW BATT** when the battery needs to be replaced, or when no battery is installed.

# SPEED DIAL OPERATION

Use with  
SPD buttons  
to access  
Speed Dial  
locations 13  
through 24

Enter programming mode

Edit Speed Dial entry

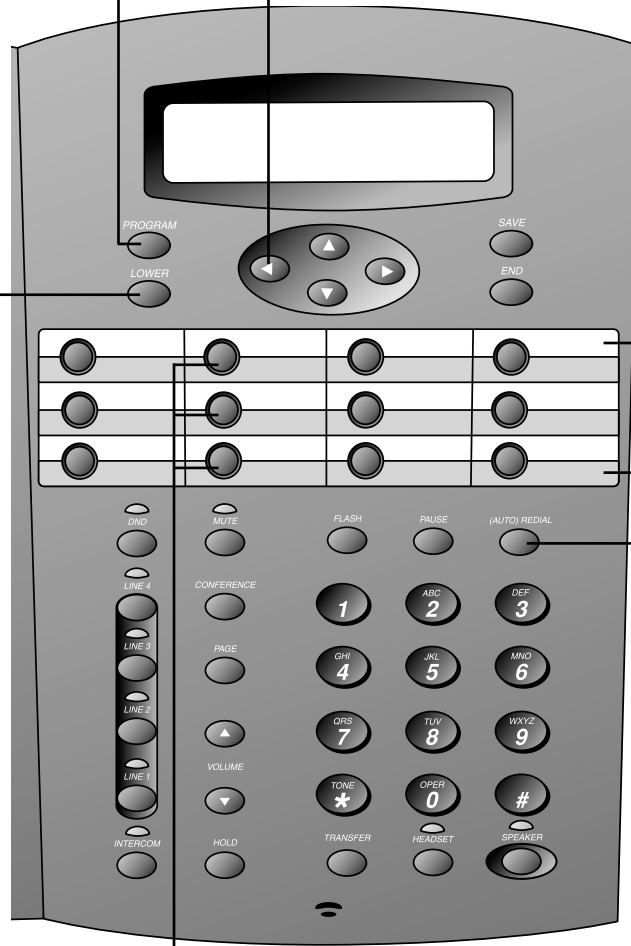

Directory card  
White spaces:  
Speed Dial  
locations 1  
through 12

Gray Spaces:  
Speed Dial  
locations 13  
through 24

Copy last  
number  
dialed into  
Speed Dial

SPD buttons

# SPEED DIAL OPERATION

This telephone has 24 Speed Dial locations where you can store phone numbers (up to 32 digits long) you wish to dial by pressing only one or two buttons.

To access locations 13 through 24, press **LOWER** and then the SPD button for the desired location.

You may wish to write the names or telephone numbers of Speed Dial entries on the directory card, using the white spaces for locations 1 through 12 and the gray spaces for locations 13 through 24.

## Storing a Number in a Speed Dial Location

- 1 Press **PROGRAM**. The screen displays:



PROGRAM: Press ▲▼  
or Enter Number

- 2 Use the dial pad keys to enter the phone number you wish to store (use **◀** to backspace),

— OR —

Press **(AUTO) REDIAL** to copy the last number you dialed onto the screen.

- 3 Press the SPD button (or **LOWER** and a SPD button) where you wish to store this entry. A confirmation tone sounds and the screen displays:



5550123  
Saved!

## Reviewing a Speed Dial Entry

Press the SPD button (or **LOWER** and a SPD button) for the location you wish to review. The screen displays any information stored in that location.

## Making a Speed Dial Call

- 1 Press the SPD button (or **LOWER** and the SPD button) for the number you wish to call.
- 2 When the entry is displayed on the screen, press the desired LINE button to place the call.

# INTERCOM OPERATION

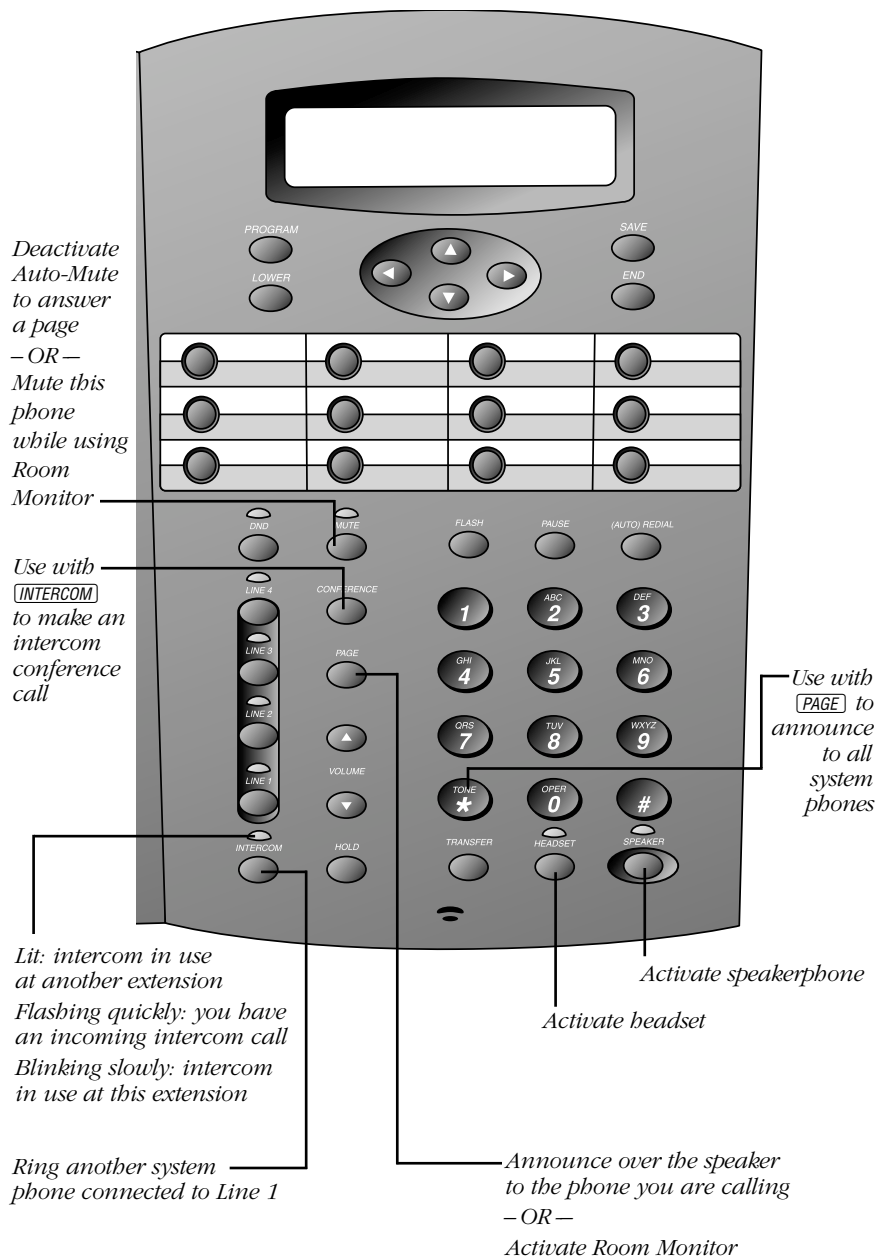

# INTERCOM OPERATION

This intercom features both a single-phone page and a system-wide page. A single-phone page alerts only one phone; a system-wide page alerts all phones. Any phone with the Do Not Disturb (DND) feature activated will not receive a page.

An intercom call rings at the extension called with a repeating double-ring pattern.

A single-phone page automatically activates the speakerphone on the receiving phone. You can deactivate the speakerphone by lifting the handset.

***NOTE:** If a line is in use, pressing **INTERCOM** or **PAGE** will place the line on hold and activate the intercom.*

## Basic Intercom Operations

- INTERCOM** Any two stations connected to Line 1 can ring each other.
- PAGE** Lets you “announce” over the speaker of the phone you’re calling. The person you’ve called can respond just by talking.
- PAGE ALL** Lets you “announce” to all phones in the system at the same time (system-wide page).
- CONFERENCE** Lets you connect another intercom call with an outside line.

## Making an Intercom Call with the Handset

- 1 Press **INTERCOM** and lift the handset. The screen displays ICM.
- 2 Dial the extension number of the party you wish to reach. If that extension is idle, you will hear long beeps. If that extension is busy, you will hear a busy signal. If that extension is set to Do Not Disturb, you will hear short beeps.

***NOTE:** The intercom call is automatically cancelled if you do not dial an extension within 10 seconds.*

***NOTE:** When you direct an intercom call to one extension, any extension in the system can answer the call by pressing **INTERCOM**.*

# INTERCOM OPERATION

## Making an Intercom Call with the Speakerphone or Headset

With the handset in the cradle and the desired line idle,

- 1 Press **INTERCOM**. The phone will automatically activate the line in the mode (headset or speakerphone) of the last call made.
- 2 Refer to the screen display and dial the extension number of the party you wish to reach. If that extension is idle, you will hear long beeps. If that extension is busy, you will hear a busy signal. If that extension is set to Do Not Disturb, you will hear short beeps.

## Answering an Intercom Call

When you receive an intercom call you will hear a repeating double-ring pattern and your screen displays **ICM** with the extension number of the caller. Answer the intercom call by lifting the handset, or by pressing **INTERCOM**, **SPEAKER** or **HEADSET** to take the call hands-free.

## Making a Single-phone Page

- 1 Press **PAGE**. The screen displays **PAGE**.
- 2 Dial the extension number of the party you wish to reach.

## Answering a Single-phone Page

### Auto-Mute Off

When your extension receives a page, the phone beeps and the speakerphone is automatically activated. Answer the call by simply speaking.

If you are on the headset, you can answer the page by pressing **HEADSET** and speaking through the headset.

### Auto-Mute On

The **MUTE** light will be on. Lift the handset or press **MUTE** to temporarily deactivate Auto-Mute and answer the page.

## Switching Between an Intercom Call and a Single-phone Page

When making an intercom call, press **PAGE** to switch the call to a single-phone page.

When making a single-phone page, press **INTERCOM** to switch the call to the intercom.

## Ending an Intercom or Page Call

Hang up or press **SPEAKER** or **HEADSET** again.

# INTERCOM OPERATION

## Paging All Phones

- 1 Press **PAGE** **✕TONE**. The screen displays **PAGE ALL**.
- 2 Speak toward the telephone or into the headset.
- 3 Press and release **SPEAKER** or **HEADSET** to disconnect.

## Answering a System-wide Page

**NOTE:** Only one extension can answer a system-wide page.

When you receive a system-wide page, your phone beeps and the screen shows the paging extension:



PAGE ALL BY 12

- 1 Press **PAGE** to answer.
- 2 To end, press and release **SPEAKER** or **HEADSET**.

## Making an Intercom Conference Call

- 1 Make or answer a call.
- 2 Press and release **INTERCOM** and enter the extension number of the third party. The line is automatically put on hold.
- 3 After the third party answers, press and release **CONFERENCE**.
- 4 To end an intercom conference call, hang up.

**NOTE:** You cannot put an intercom conference call on hold.

## Room Monitor

You can activate the speaker of another phone to monitor sounds in that room.

- 1 Press and release **PAGE**.
- 2 Enter the extension number of the telephone to be monitored.
- 3 Press and release **MUTE** if you don't want sounds on your end to be heard.
- 4 To end monitoring, press and release **SPEAKER**.

The party at the extension being monitored will hear a beep as with any page, signaling that the speakerphone has been activated.

**NOTE:** An extension cannot be monitored when Auto-Mute is turned on at that extension.

# ADDING A FAX MACHINE

***NOTE:** Do not connect a fax machine to Line 1. Doing so will interrupt the telephone intercom data channel.*

You may wish to use a fax machine with your phone. Choose Line 2, 3 or 4 for the fax machine, and connect it according to the manufacturer's instructions for installation and use.

- That line's telephone number is your fax number.
- The same line can be used for outgoing calls (incoming faxes will get a busy signal).
- Set your fax machine to answer on the first ring (follow manufacturer's instructions).
- To prevent the fax line from ringing at all the extensions, turn the ringer off for that line (see "Turn Ringer On or Off" in FEATURE SET UP).

***NOTE:** If you are using a fax switch, or a fax machine with a built-in fax switch, see "Using a Fax Switch."*

## **Using a Fax Switch**

A fax switch lets the telephone know, before the phone rings, whether an incoming call is a voice call or a fax call. Some fax machines have a built-in fax switch. Using a fax switch may affect the operation of Line-in-use lights.

# IN CASE OF DIFFICULTY

If you have difficulty operating this phone, try the suggestions below. For Customer Service, visit our website at [www.telephones.att.com](http://www.telephones.att.com) or call 1 800 223-3111. **Please retain your receipt as your proof of purchase.**

## Telephone Does Not Ring

- Make sure the Do Not Disturb (DND) feature is not activated.
- Make sure ringers are turned on.
- If there are several non-system phones on the line that don't ring, disconnect some of them. Having too many phones connected can also result in low ringer volume for non-system telephones.
- If the INTERCOM light flashes but you don't hear a paging signal, make sure the Do Not Disturb feature is not activated.

## Intercom Paging Signal Not Received

Make sure you have programmed your intercom extension number correctly. Line 1 must be connected at all extensions, and must be the same telephone number/line for Page and Intercom to work properly.

## Cannot Join a Conversation in Progress

The privacy feature prevents another set on the system from interrupting a conversation. Make sure you press the LINE button to release privacy.

## Error Tone (Fast Busy Signal) Heard When Making an Intercom Call

The Do Not Disturb feature is activated at the extension you are calling.

## Line Lights Remain On When No Line is Connected

- Make sure the phone is programmed for that line to be absent. (See "Set Line Usage for Each Line" in FEATURE SET UP.)
- Make sure that your Line Groups are programmed properly. (See "Assign the Line Group for this Phone" in FEATURE SET UP.)
- Disconnect all other devices (fax, modem, credit card reader, etc.) from any lines connected to your 944 phone. These devices can interfere with the telephone's data links.
- Make sure the total length of telephone wiring used in your phone system is less than 600 feet. If the wiring is longer, you may need to use a special filter device. Call 1 800 222-3111 for information about this filter. You'll need to contact a professional to install this filter.

# IN CASE OF DIFFICULTY

## **Tone Signals Do Not Activate a Remote Device**

- Tone signaling does not work during conference calls.

## **Operation During a Power Failure**

This phone will operate during a power failure if a working battery has been installed. You will be able to answer calls with the handset or headset, and dial calls using the keypad and the Speed Dial or Redial features. No other features will work until power is restored.

## **Display Screen is Blank**

Make sure the power cord is connected to both the phone and an electrical outlet not controlled by a wall switch.

# EXPANDING THE PHONE SYSTEM

When you combine two or more 944/955/964 phones you create an interacting system where phones share lines. You can have up to 12 phones and up to 15 telephone lines. The system can be expanded with or without Centrex service.

**NOTE:** All 944 features work as described earlier in this manual.

## Line Groups

When phones share lines, Line-in-use lights let users at different extensions know when a specific line is in use. For accurate Line-in-use lights, the same lines must be connected to each extension in the Line Group, and they must have the same incoming telephone number at each extension.

The chart below shows 12 extensions, each sharing the first three lines, but being assigned to different Line Groups based on other shared or private lines.

		Lines in System					
		L1	L2	L3	L4	L5	L6
Intercom Stations	ICM 11	✓	✓	✓	✓		
	ICM 12	✓	✓	✓		✓	
	ICM 13	✓	✓	✓	✓		
	ICM 14	✓	✓	✓		✓	
	ICM 15	✓	✓	✓	✓		
	ICM 16	✓	✓	✓		✓	
	ICM 17	✓	✓	✓	✓		
	ICM 18	✓	✓	✓		✓	
	ICM 19	✓	✓	✓	✓		
	ICM 20	✓	✓	✓		✓	
	ICM 21	✓	✓	✓	✓		
	ICM 22	✓	✓	✓			✓

# EXPANDING THE PHONE SYSTEM

## Private Lines

You can use the fourth line on each station as a private line. A private line is a telephone number assigned to just one extension.

*NOTE: You must program the lines you are using at each extension so that the phone knows which lines are shared and which are private (you cannot physically wire lines with different telephone numbers into each unit for Line 4).*

The chart below shows 12 extensions, each sharing the first three lines and having its own private line.

		Lines in System														
		L1	L2	L3	L4	L5	L6	L7	L8	L9	L10	L11	L12	L13	L14	L15
Intercom Stations	ICM 11	✓	✓	✓	✓											
	ICM 12	✓	✓	✓		✓										
	ICM 13	✓	✓	✓			✓									
	ICM 14	✓	✓	✓				✓								
	ICM 15	✓	✓	✓					✓							
	ICM 16	✓	✓	✓						✓						
	ICM 17	✓	✓	✓							✓					
	ICM 18	✓	✓	✓								✓				
	ICM 19	✓	✓	✓									✓			
	ICM 20	✓	✓	✓										✓		
	ICM 21	✓	✓	✓											✓	
	ICM 22	✓	✓	✓												✓

# CENTREX OPERATION

## Setup Checklist

Before expanding your system or installing for Centrex, review the installation checklist. If you have Centrex, contact your local telephone company for further information about Centrex service.

- The phone number for Line 1 must be the same on all phones in order for the Intercom and Page features to work.
- Determine the number of phones that will be on the system.
- Identify the phone that will be the Console phone.
- Identify the private line for the Console phone. The Console phone must have its own private line. This line is not shared with any other phone.
- Follow the regular installation instructions in this manual.
- Enable the Console phone.
- Store the Centrex pickup codes and the seven-digit phone numbers in Speed Dial locations. (See SPEED DIAL OPERATION in this manual.)

## Enabling the Console Phone

Determine which phone will be the Console phone for your system and program the Console following the directions to “Set Your Phone to be the Centrex Console Phone” in FEATURE SET UP. It is recommended that Line 4 of the Console be programmed as a private line, to be sure a line is available for Centrex access.

## Console Operation

Once another system phone has enabled its delayed ring, the Console phone will receive those calls. All the 944 features work in the same manner as described in this manual.

The Console phone can pick up other Centrex lines through Centrex switching. The Console can store the Centrex pickup codes and the seven-digit phone number of each station, except for the Console phone, in the Speed Dial locations.

# CENTREX OPERATION

## Setting Ring Delay Duration

This feature allows other system telephones' calls to ring at the Console phone. After a specified ring delay, the calls will ring at the Console phone. (See "Program the Centrex Console Delayed Ring Time" in FEATURE SET UP.)

## Answering a Delayed Ring

The Console phone rings and the screen displays the station number of the intercom sending the delayed ring.

- 1 Select a free line.
- 2 Enter the Centrex pickup code.
- 3 Enter the seven-digit phone number of the station sending the delayed ring.

***NOTE:** If the Console is using another line and receives a delayed ring, the Console phone can put the other line on hold and follow **Steps 1–3**. If the Console is on an intercom call, the intercom call should be ended before picking up the ringing phone.*

## Picking Up Another Station's Line

- 1 Choose a free Centrex line.
- 2 Enter the Centrex pickup code.
- 3 Enter the seven-digit phone number of the line you want.

# INDEX

- ▲ 3, 13-18
- ▼ 3, 13-18
- ⑦ 18
- ◀ 3, 28
- ▶ 3, 13-18
- AM 14
- AUDIO MODE 4, 17
- (AUTO) REDIAL** 23, 24, 28
- Auto Redial 19, 24
- Auto-Mute 4, 16, 29, 31, 32
- Call Privacy 22
- Call Waiting 25
- Centrex 18, 36, 38, 39
- Centrex Service 3
- Conference 30
- (CONFERENCE)** 25, 26, 32
- Conference Calls 25, 26
- CONSOLE 18
- CONSOLE 4, 39
- Console phone 18, 38, 39
- CSL DELAY RING 4, 18
- Default settings 4, 18
- DELAY RING 4, 15
- Delayed Ring 39
- Dial mode 4, 17
- DND 22
- (DND)** 22
- DND 3, 5, 22, 30, 34
- DND light 22
- Do Not Disturb 3, 22, 30, 31, 34
- (END)** 3, 13
- EXTENSION NO 4, 14
- Extension Number 2-6, 30-32, 34
- (FLASH)** 4, 25
- Flash 25
- FLASH TIME 17
- FLASH TIME 4, 25
- Handset 19-21, 23, 25, 31
- Headset 19-21, 24-26, 29, 31
- (HEADSET)** 3, 4, 21, 24, 31, 32
- Headset light 21
- Hold 24, 30, 32
- HOLD REMINDER 4, 17
- ICM 30, 31
- Initializing.. 8, 11
- Intercom 2, 5, 24, 29, 30-33, 34, 38, 39
- (INTERCOM)** 24, 29, 30-32
- Intercom conference call 29, 32
- INTERCOM light 22, 34
- LINE GROUP 4, 16
- Line Groups 3, 34, 36
- LINE light 22
- LINE USAGE 15
- LINE USAGE 4, 34
- Line-in-use lights 19, 23, 33, 36
- LOW BATT 26
- (LOWER)** 28
- Mute 19, 25
- (MUTE)** 25, 31, 32
- Mute light 25, 31
- Navigation buttons 3, 13
- Page 2, 30, 31, 34, 38
- (PAGE)** 24, 29- 32
- (PAGE) (X-TONE)** 32
- PAGE ALL 30, 32
- Pause 19, 21
- (PAUSE)** 21
- PM 14
- POWERFAIL 8, 10
- PRIME LINE 4, 16
- Prime Line 3, 20
- Private line 2, 36-38

# INDEX

**PROGRAM** 13-18, 28

PRV 4

Redial 6, 9, 19, 23, 24, 35

RESET! 18

RESET ALL!!! 4

RESET ALL 18

RESET ALL? 18

Ring Delay 39

Ringer 19, 23

RINGER ON/OFF 4, 14

RINGER TYPE 4, 15

Room Monitor 29, 32

**SAVE** 3, 13-18

Single-phone page 30, 31

SPD button 27, 28

**SPEAKER** 3, 4, 20, 21, 24, 31, 32

SPEAKER light 20

Speakerphone 17, 19-21, 24-26, 29, 30-32

Speed Dial 6, 9, 27, 35

Speed Dial locations 27, 28, 38

System-wide page 30, 32

Temporary tone 19, 25

Three-party call 19

Three-Way Calling 25

TIME/DATE 4, 14

Timer 21

**X-TONE** 25

TONE/PULSE 4, 17

**TRANSFER** 26

Transfer 26

Transferred call 5

Volume 23

Volume ▲ 23, 24

Volume ▼ 23, 24

